

SEZIONE A-A

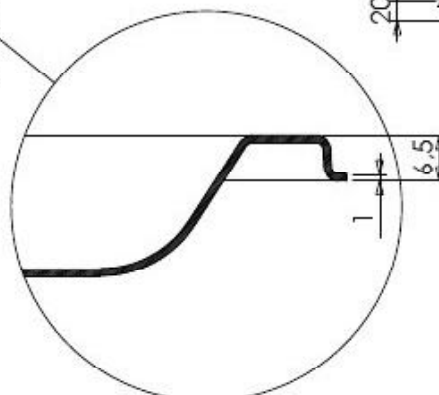

DETTAGLIO

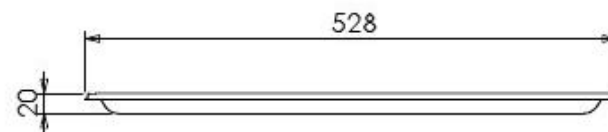
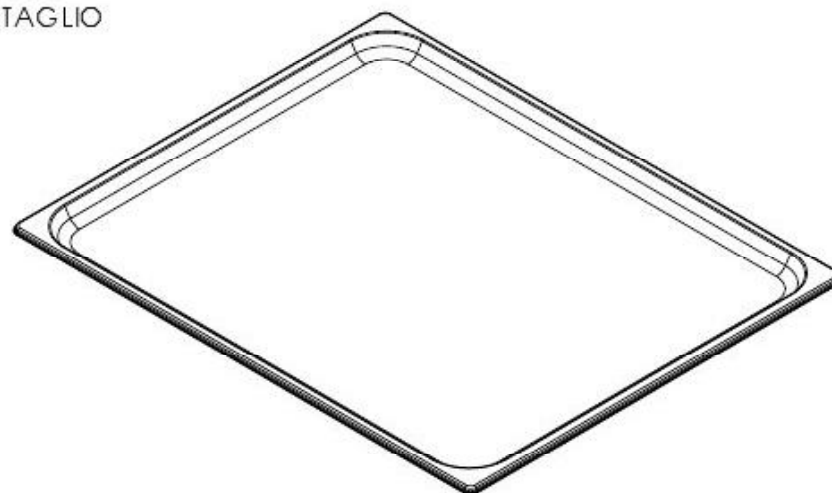
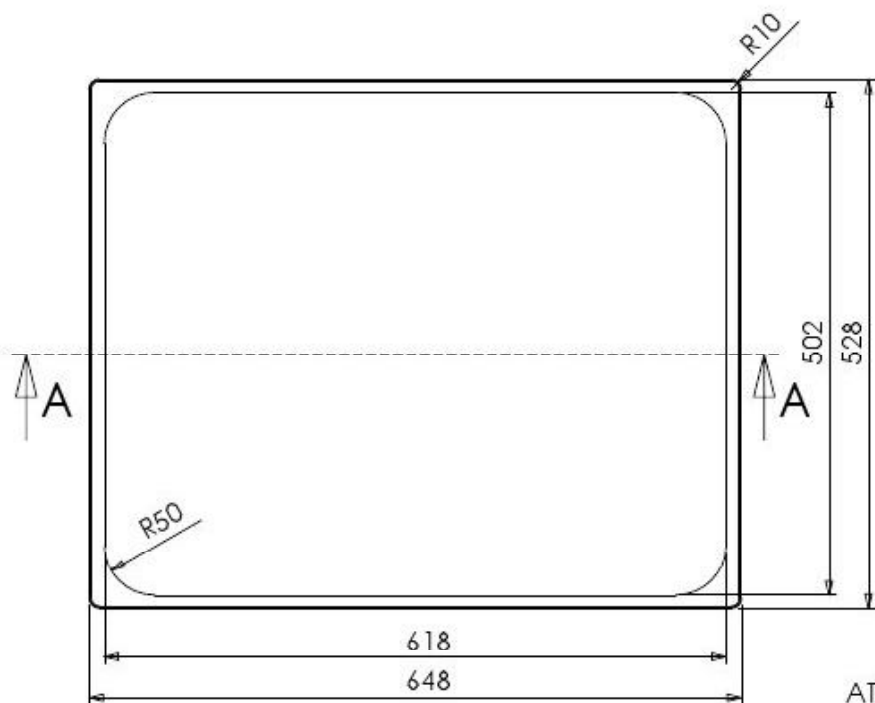

ATTENZIONE:
SP. 1 mm

TOLLERANZA +/- 1 mm

GASTRONORM 2/1x020

NR. DISEGNO	
DATA:	13/04/2010
MATERIALE:	AISI 304
CLIENTE:	



SCALA: 1:7

FOGLIO 1 OF 1